

PicoSource[®] PG900 Series

USB differential pulse generators



Three PicoSource models

Integrated 60 ps pulse outputs: PG911
Tunnel diode 40 ps pulse heads: PG912
Both output types: PG914

Integrated pulse outputs

Differential with deskew
60 ps transition time
2.5 V to 6 V amplitude

Tunnel diode pulse heads

Differential with deskew
40 ps transition time
200 mV amplitude

Advanced features

Output deskew with 1 ps resolution
Low-jitter trigger input and output
User-variable pulse width
Internal trigger clock
Trigger hold-off

Configuration

USB 2.0 connected
Microsoft Windows compatible

Applications

TDR/TDT network and match analysis
Spectral and flatness measurements
Timing, jitter, and crosstalk determination
Semiconductor testing
Impulse ultra-wideband radars
Laser diode drivers

PicoSource PG900 Series

USB differential pulse generators

The fast-transition pulse can stimulate a transmission path, device, or network with a broad-spectrum signal in a single instant. These signals, combined with differential capability, are valuable for making high-speed broadband measurements in many fields such as time domain reflectometry, semiconductor testing, gigabit interconnect and port testing, and in radar systems.

High-speed differential data is becoming the dominant measurement challenge in digital, computing, interconnect and telecommunications systems. Despite this need, cost-effective, fast-transition differential pulse generators were hard to find ... until now.

Key specifications

PicoSource PG911 and PG914

- Integrated 50 Ω SMA(f) step recovery diode outputs
- < 60 ps single-ended pulse transition time
- Two 2.5 V to 6 V variable amplitude outputs
- ± 1 ns timing deskew in 1 ps steps
- 20 dB 10 GHz SMA(m-f) attenuators supplied fitted to SRD pulse outputs

PicoSource PG912 and PG914

- External 50 Ω N(m) positive and negative tunnel diode pulse heads
- < 40 ps pulse transition time
- Fixed 200 mV output amplitude
- ± 500 ps timing deskew in 1 ps steps
- Inter-series N(f)–SMA(m) adaptors included with pulse heads

All PicoSource PG900 models

- Differential outputs
- 200 ns to 4 μ s pulse width
- Adjustable 1 μ s to 1 s internal clock period
- Typical 3.0 ps RMS jitter relative to external trigger



A versatile, portable pulse generator

The PicoSource PG900 Series of low-jitter triggered differential USB pulse generators offer a range of advanced features:

- The pulse outputs are optimized for broad spectral content (fastest transition time) to best suit spectral and time-domain transmission and reflectometry measurements
- The internal clock provides stand-alone, self-triggered operation
- Trigger input and output allow the pulse generators to source or respond to system triggers
- Differential outputs ensure that the proliferation of gigabit differential interconnects and systems (such as SATA, USB3, HDMI, Ethernet) can all be addressed

Essential to any differential measurement is the ability to adjust for small but significant velocity and path length differences that are bound to exist in any measurement setup. The PicoSource PG900 pulse generator outputs can each be adjusted (time-skewed) by 1 ns (integrated pulse outputs) or 200 ps (tunnel diode pulse heads) in 1 ps increments to deskew path differences before the measurement, or to deliberately stress a transmission path with timing skew.

Despite their small size and portability, PicoSource pulse generators have plenty of drive capability, with integrated step recovery diode outputs of up to 6 V pk each into 50 Ω . That's a powerful 12 V pk differential pulse amplitude to drive lossy paths or stress system ports. Outputs are adjustable in 10 mV steps down to 2.5 V pk. An adjustable amplitude limit is provided to protect sensitive devices, and 20 dB attenuators are supplied fitted to the pulse outputs for small-signal optimal match applications.

Step recovery diode variable-amplitude pulse

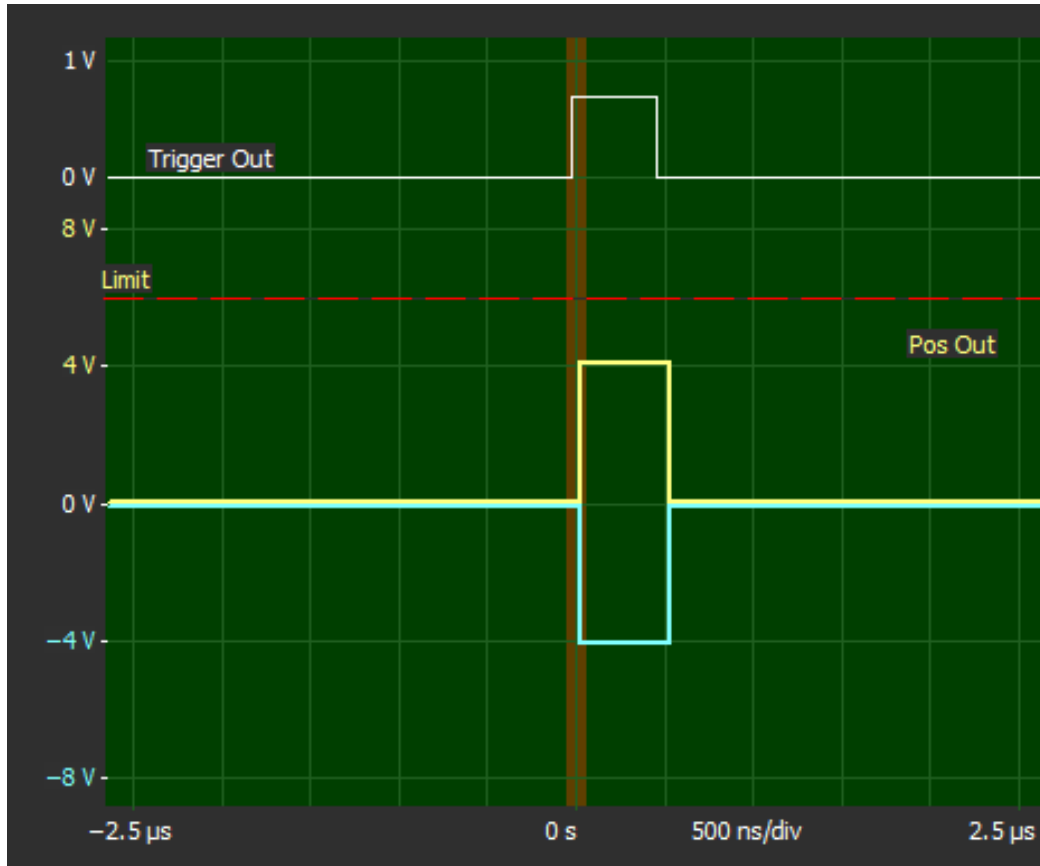

The positive (fast rise) and negative (fast fall) pulses are both ground-referenced and each pulse is in opposite polarity to its selected amplitude. This amplitude (the “mark”) is held for the selected pulse width and then returns to ground. Further pulses are prevented for the selected hold-off period and thereafter repeat at 40 ns after the next received trigger. When the internal clock is selected, the pulse repeats at the selected period and hold-off is inactive. An output trigger is generated 40 ns before every pulse, however initiated.

Pulse transition time is typically 55 ps and spectral content extends to 12 GHz.

The negative (fast fall) pulse can be selected for even faster transition time by selecting “fast” rather than “smooth” mode. Pulse aberration is compromised but transition time is typically 45 ps and spectral content extends to around 14 GHz.

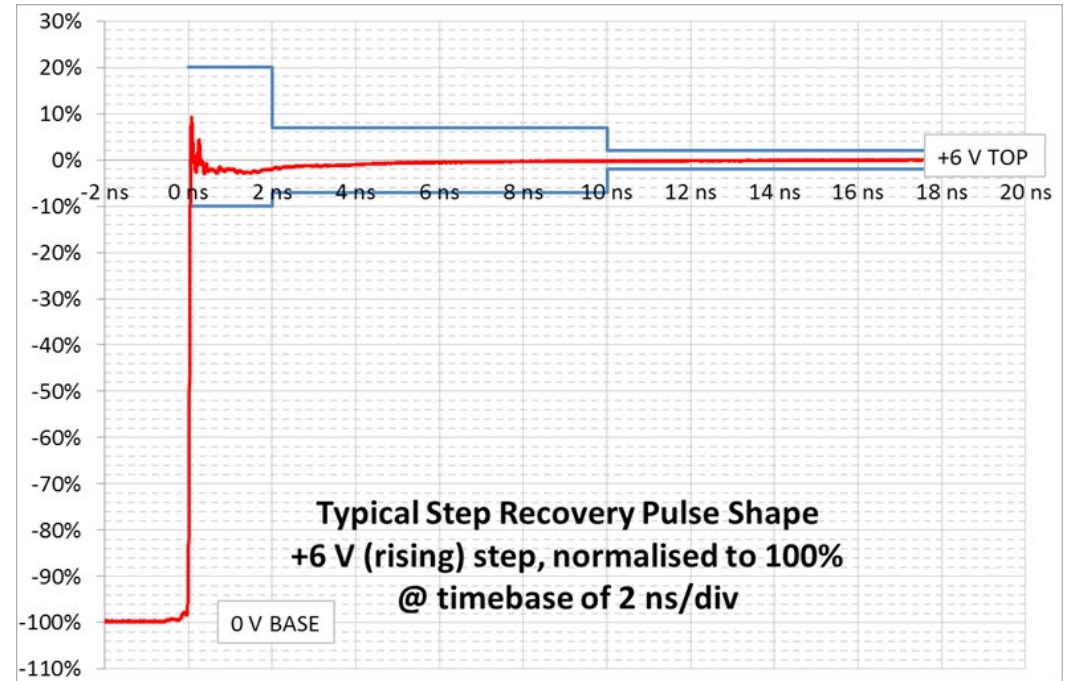

Tunnel diode head fixed-amplitude pulse

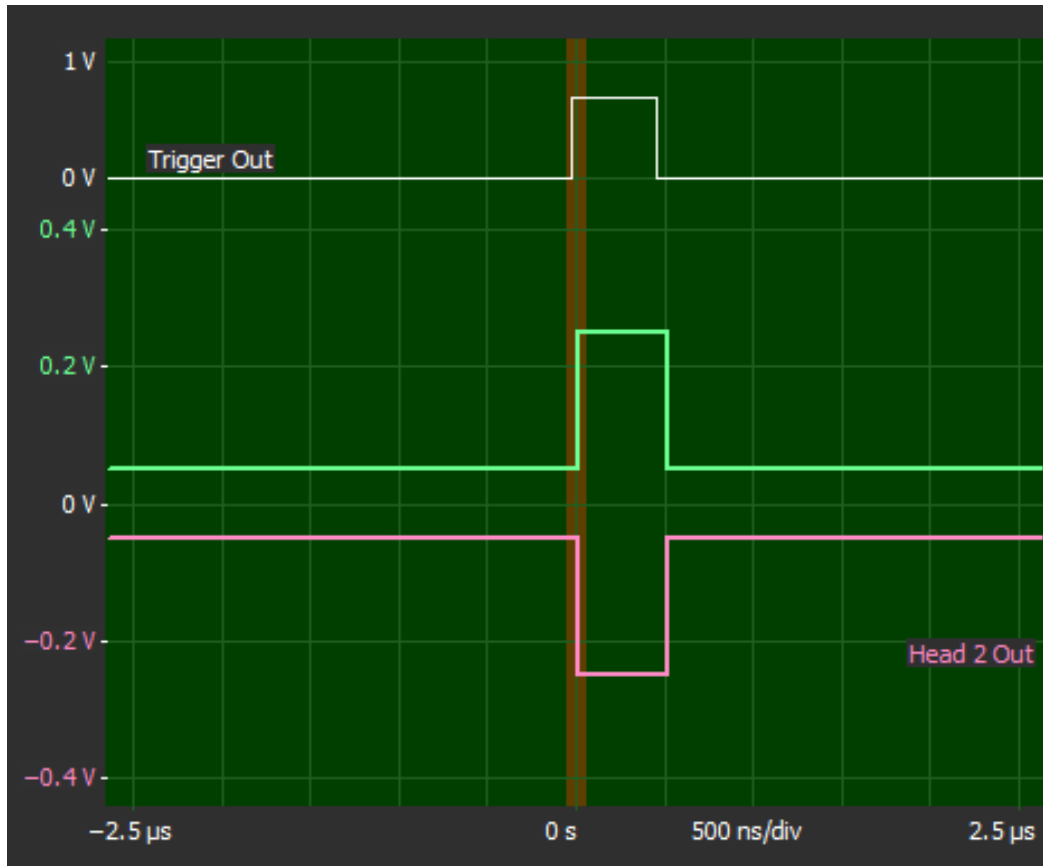

The positive (fast rise) and negative (fast fall) pulses are both DC offset referenced and each pulse in opposite polarity by its independent fixed amplitude. This amplitude (the “mark”) is held for the selected pulse width and then returns to ground. Further pulses are prevented for the selected hold-off period and thereafter repeat at 40 ns after the next received trigger. When the internal clock is selected, the pulse repeats at the selected period and hold-off is inactive. An output trigger is generated 40 ns before every pulse, however initiated.

Pulse transition time is typically 40 ps and spectral content extends to 14 GHz.

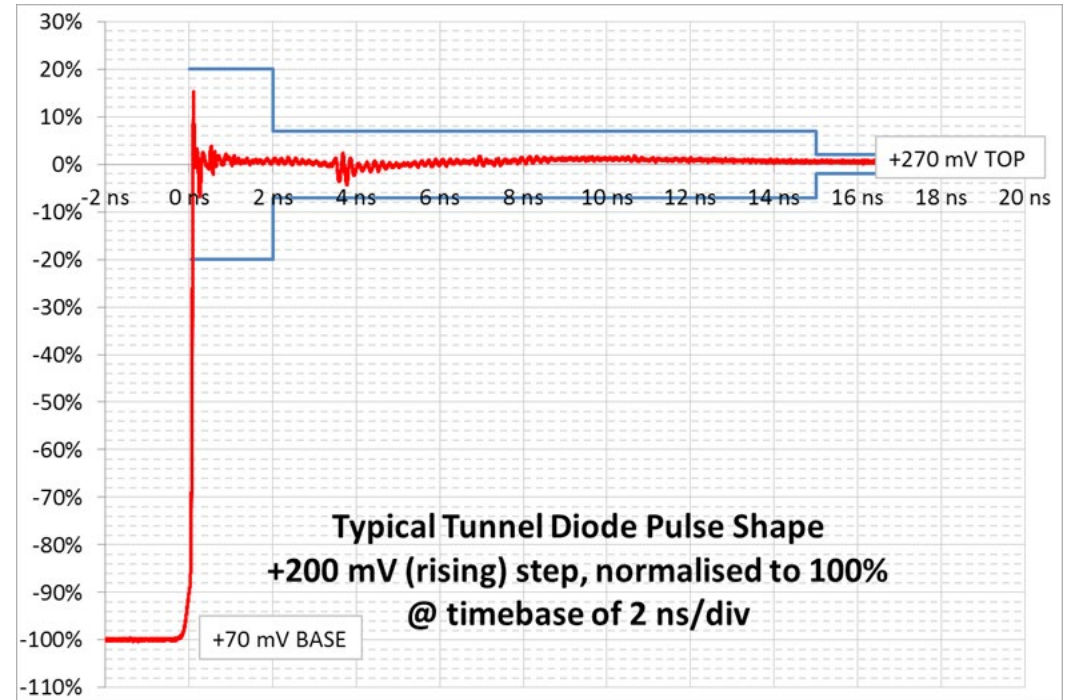

Connection diagrams

The following diagrams demonstrate differential and single-ended TDR and TDT setup options for a PicoSource pulse generator, PicoScope 9300 Series sampling oscilloscope, and the device under test (DUT). In all setups shown, the PG911 or PG912 pulse generator can be replaced by a PicoSource PG914.

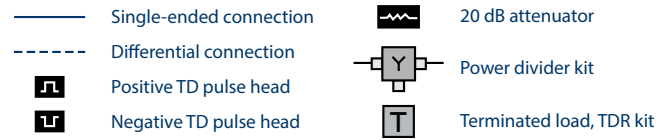

TDR applications

PicoSource pulse generators can be used to realize time domain reflectometry with a PicoScope 9300 Series sampling oscilloscope without that function (PicoScope 9301, 9302, 9321 and 9341).

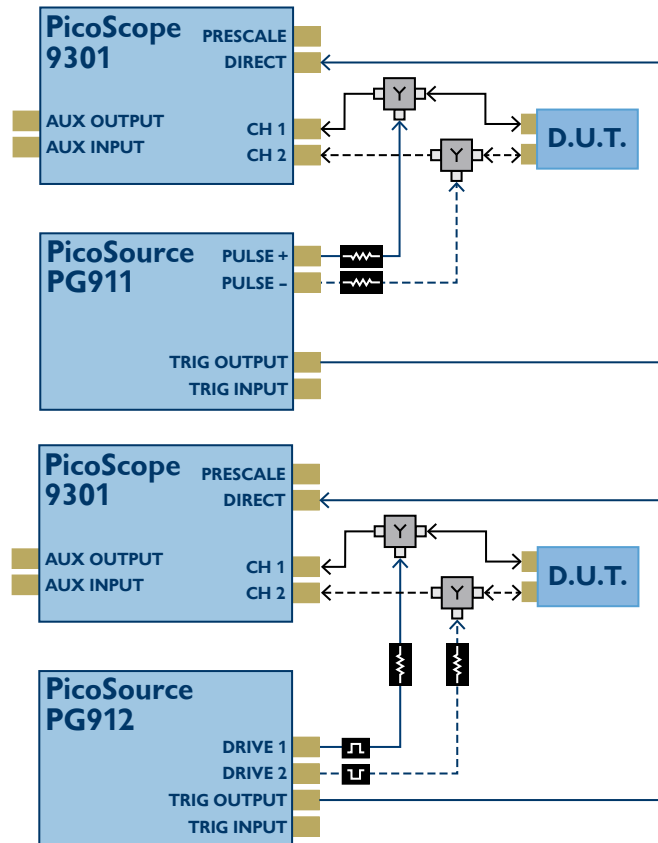

TDT applications

PicoSource pulse generators can also be used to realize time domain transmission (TDT) with a PicoScope 9300 sampling oscilloscope without that function (PicoScope 9301, 9302, 9321, and 9341). They also offer the versatility of a remotely-placed signal generator for long line or installed system testing when used with any of the PicoScope 9300 models.

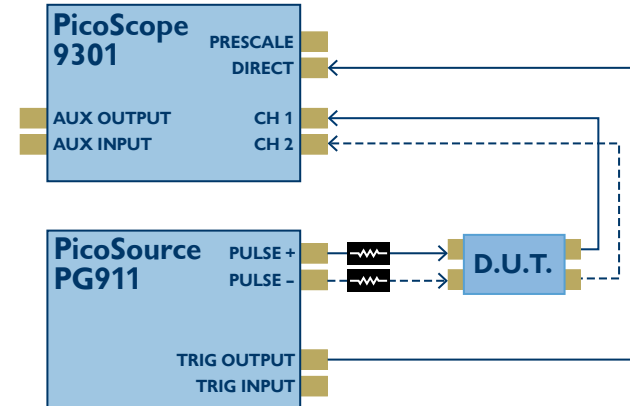

TDT and crosstalk application

PicoSource pulse generators can be used with a PicoScope 9341 four-channel sampling oscilloscope for simultaneous time domain transmission and crosstalk assessment.

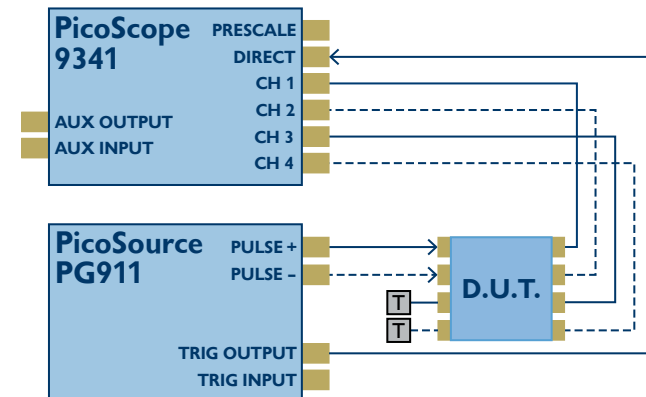

Single-ended measurements

Single-ended measurements can be performed with a two-channel sampling oscilloscope. Differential measurements can also be tackled by first measuring transmission and then changing connections for crosstalk measurement. Unconnected ports should be correctly terminated in this case.

PicoSource PG900 pulse control software for Windows

PicoSource pulse generators are connected by USB, and controlled by the supplied PicoSource PG900 software. This straightforward application runs on Microsoft Windows and features a clear graphical display of the pulse, limits and trigger settings as they are applied. Default and user pulse settings can be saved for future use, and the software can be tested in demonstration mode.

PicoSource PG900 software can be downloaded from www.picotech.com.

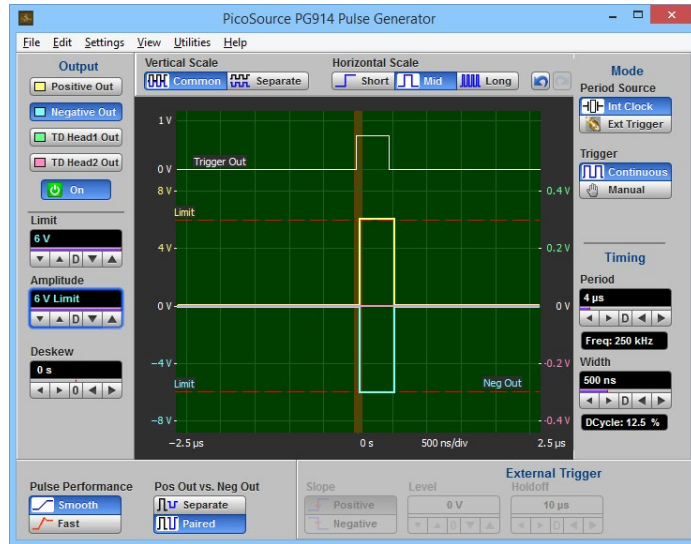

Front and rear panels

PicoSource PG911



SRD
pulse outputs

Trigger output
and input

PicoSource PG912



TD pulse head
drive outputs

Trigger output
and input

PicoSource PG914



SRD
pulse outputs

TD pulse head
drive outputs

Trigger output
and input

All models



DC
power
input

USB
port

Signal
ground
terminal

PicoSource PG900 Series pulse generator specifications

PicoSource PG911 and PG914

INTEGRATED STEP RECOVERY DIODE PULSE OUTPUTS

Pulse outputs	Positive-going (fast rise) and negative-going (fast fall) outputs returning to 0 V. Adjustable amplitude and timing parameters. Fast transition on leading edge.	
Output impedance	50 Ω	
Output connector	SMA(f)	
Output amplitude	Adjustable 2.5 V to 6 V in 10 mV steps	
Output accuracy	$\pm 10\%$	
Output amplitude limit	2.5 V to 6 V, adjustable in 100 mV increments	
Output protection limit	± 10 V DC, or AC peak	
Duty cycle limit	50% maximum (for 2.5 V to 4 V amplitude) 20% maximum (up to 6 V amplitude)	
Differential deskew range	Adjustable in 1 ps steps over 2 ns range	
	POSITIVE OR NEGATIVE-GOING, SMOOTH MODE	NEGATIVE-GOING, FAST MODE
Pulse transition time	< 60 ps (10% to 90%)	< 50 ps (10% to 90%)
Pulse aberrations	< +20%, -10% for first 2 ns < $\pm 7\%$ to 10 ns < $\pm 2\%$ to (pulse width-50 ns)	< +40%, -10%
Trailing edge transition time	< 8 ns (10% to 90%)	

PicoSource PG912 and PG914

DRIVE OUTPUTS WITH TUNNEL DIODE PULSE HEADS

Positive tunnel diode pulse head	Positive-going (fast rise) output on < 70 mV pedestal. Fixed amplitude and adjustable timing parameters. Fast transition on leading edge.
Negative tunnel diode pulse head	Negative going (fast fall) output on < -70 mV pedestal. Fixed amplitude and adjustable variable timing parameters. Fast transition on leading edge.
Output impedance	50 Ω , ± 2 Ω
Output connector	N(m)
Output amplitude	Fixed 200 mV
Output protection limit	± 0 V DC, or AC peak, except open or short circuit reflection of the source signal. No prolonged reverse bias allowed.
Output accuracy	$\pm 25\%$
Differential deskew range	Adjustable in 1 ps steps over 200 ps minimum, 300 ps typical
Pulse transition time	< 40 ps (10 % to 90%)

PicoSource PG900 Series pulse generator specifications

Pulse aberrations	< $\pm 20\%$, for first 2 ns < $\pm 7\%$ to 15 ns < $\pm 2\%$ to (pulse width – 50 ns)
Trailing edge transition time	< 8 ns (10% to 90%)
Dimensions (each pulse head)	80 mm x 28 mm x 25 mm
Weight (each pulse head)	125 g

All models and outputs

PULSE TIMING

Pulse trigger source	External input, manual single shot event or internal clock
Jitter relative to leading edge	3.0 ps RMS typical. 3.5 ps RMS maximum.
Post-trigger delay to pulse leading edge	Fixed 42 ns ± 2 ns Allows leading-edge capture on sampling oscilloscopes
Pulse width and accuracy	200 ns to 4 μ s $\pm 10\%$ ± 50 ns, adjustable in steps of 25 ns
Pulse width jitter	< 150 ppm of width RMS
External trigger hold-off	Adjustable 1 μ s to 1.3 ms in steps of 200 ns, to maximum of 345 ms in steps of < 15 ppm

INTERNAL CLOCK SPECIFICATION

Period and accuracy	Adjustable 1 μ s to 1 s, ± 100 ppm ± 10 ns in steps of 200 ns
---------------------	---

EXTERNAL TRIGGER INPUT SPECIFICATION

Impedance	50 Ω $\pm 1\%$
Connector	SMA(f)
Maximum input level	+16 dBm, or ± 2 V DC or AC pk
Bandwidth	1 GHz, DC coupled
Trigger polarity	Selectable rising or falling edge
Trigger level	Selectable -1 V to +1 V in steps of 1 mV
Sensitivity	< 50 mV pk-pk DC to 100 MHz, rising linearly to 100 mV pk-pk at 1 GHz
Minimum pulse width	500 ps at 100 mV pk-pk

EXTERNAL TRIGGER OUTPUT SPECIFICATION

Trigger output pulse	Fixed amplitude and timing parameters, positive edge polarity, trigger is leading edge
Impedance	50 Ω , ± 0.5 Ω
Connector	SMA(f)
Amplitude and offset	> 700 mV fixed, on logic low of 0 V \pm < 100 mV
Pulse width	500 ns, ± 100 ns
Trigger to trigger output delay	4 ns, ± 1 ns
Trigger to trigger output jitter	2.5 ps RMS typical. 3 ps RMS maximum.
Transition time	< 400 ps (10% to 90%)

PicoSource PG900 Series pulse generator specifications









GENERAL SPECIFICATIONS



AC to DC adaptor	5 V \pm 5% at 1.6 A, 8 W, universal plug (adaptor included)
PC connection	USB 2.0 (USB 1.1 and USB 3.0 compatible), 1.8 m USB 2.0 lead included
PC requirements	Windows XP SP3 to Windows 8
Operating temperature range	+5 °C to +35 °C
Storage temperature range	-20 °C to +50 °C
Temperature range for stated specifications	+15 °C to +25 °C or T_{CAL} (temperature of calibration) \pm 5 °C
Operating humidity range	< 85% RH (non-condensing) at +35 °C
Storage humidity range	< 95% RH (non-condensing)
Altitude range	Up to 2000 m
Pollution degree	2
Ingress protection	IP20
Dimensions (instrument)	190 mm W x 180 mm D x 40 mm H
Weight (instrument)	560 g
Compliance	FCC (EMC), CE (EMC and LVD)
Warranty	5 years

Specifications describe guaranteed performance over the stated temperature range and apply after the instrument's temperature has been stabilized in one hour of continuous operation. All specifications are subject to change without notice.

Factory calibration cycle. For optimum performance, the instrument should have a complete verification of specifications once every 12 months.

Optional accessories

Order code	Model name	Description	
TA237	TA237 14 GHz 25 ps TDR kit	18 GHz 50 Ω SMA(m-m) within-series adaptor 18 GHz SMA(f) reference short 18 GHz SMA(f) reference load	
TA238	TA238 14 GHz power divider kit	18 GHz 50 Ω SMA(f-f) 3-resistor 6 dB power divider 2 x 10 cm precision coaxial SMA(m-m) cable For use with a PicoScope 9300 Series oscilloscope	
TA181	TA181 attenuator 3 dB	10 GHz 50 Ω SMA (m-f)	
TA261	TA261 attenuator 6 dB	10 GHz 50 Ω SMA (m-f)	
TA262	TA262 attenuator 10 dB	10 GHz 50 Ω SMA (m-f)	
TA173	TA173 attenuator 20 dB	10 GHz 50 Ω SMA (m-f)	
TA172	TA172 inter-series adaptor	18 GHz, 50 Ω N(f) -SMA(m)	
TA170	TA170 connector saver adaptor	18 GHz 50 Ω SMA(m-f)	
TA263	TA263 precision high-flex unsleeved coaxial cable	60 cm, SMA(m-m) < 1.7 dB loss @ 10 GHz	

Order code	Model name	Description	
TA264	TA264 precision high-flex unsleeved coaxial cable	30 cm, SMA(m-m) < 1.1 dB loss @ 10 GHz	
TA265	TA265 precision sleeved coaxial cable	30 cm, SMA(m-m) < 1.1 dB loss @ 10 GHz	

* Prices correct at the time of publication. Sales taxes not included. Please contact Pico Technology for the latest prices before ordering.

Kit contents



PicoSource PG911



PicoSource PG912



PicoSource PG914

ALL KITS CONTAIN:

PicoSource PG900 software disk • Quick Start Guide • AC to DC adaptor 5 V DC at 2 A, universal input
USB 2.0 cable 1.8 m • SMA/PC3.5/2.92 wrench • Storage and carry case

Order code	Description	PG911	PG912	PG914
Not available separately	Positive 40 ps tunnel diode pulse head (attached to the device)		•	•
Not available separately	Negative 40 ps tunnel diode pulse head (attached to the device)		•	•
TA172	12 GHz N(f) to SMA(m) adaptor (2 pack)		•	•
TA173	10 GHz 20 dB SMA(m-f) attenuator (2 pack)	•		•
Not available separately	50 Ω coaxial SMA(m-m) pulse drive cable 60 cm (2 pack)		•	•

Ordering information

Pulse generators

Order code	Model name	Description
PP977	PicoSource PG911	50 Ω SMA(f) < 60 ps differential pulse outputs, 2.5 V to 6 V variable amplitude
PP978	PicoSource PG912	50 Ω N(m) < 40 ps positive and negative tunnel diode pulse heads, > 200 mV fixed amplitude
PP979	PicoSource PG914	Dual-mode generator with both of the above outputs

* Prices are correct at the time of publication. Sales taxes not included. Please contact Pico Technology for the latest prices before ordering.

More RF products from Pico...

**PicoConnect
900 Series**
9 GHz passive
probes



**PicoScope
9300 Series**
Sampling scopes
and TDR to 25 GHz

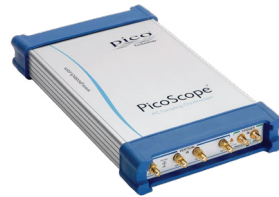

**PicoScope
9404-05**
Sampler extended
real time scopes



PicoVNA 106
Making vector
network analysis
accessible



**PicoSource
AS108**
8 GHz agile
synthesizer



UK global headquarters:

Pico Technology
James House
Colmworth Business Park
St. Neots
Cambridgeshire
PE19 8YP
United Kingdom

☎ +44 (0) 1480 396 395
✉ sales@picotech.com

North America regional office:

Pico Technology
320 N Glenwood Blvd
Tyler
Texas 75702
United States

☎ +1 800 591 2796
✉ sales@picotech.com

Asia-Pacific regional office:

Pico Technology
Room 2252, 22/F, Centro
568 Hengfeng Road
Zhabei District
Shanghai 200070
PR China

☎ +86 21 2226-5152
✉ pico.china@picotech.com

(Authorized Distributor)

Analytical Electronics Services Pvt. Ltd.



B-76, G.I.D.C. Electronics Estate, Opp. Water Tank,
Sector-25, GANDHINAGAR-382 024, Gujarat (INDIA)
Tel : +79-(0)79-23287267, 29289167,
Fax : +91-(0)79-23287266
E-mail : sales@analyticalelectronics.in,
info@analyticalelectronics.in

Errors and omissions excepted. *Pico Technology*, *PicoSource* and *PicoScope* are internationally registered trademarks of Pico Technology Ltd. *PicoConnect* and *PicoVNA* are registered trademarks of Pico Technology Ltd.

Windows is a registered trademark of Microsoft Corporation in the United States and other countries.

MM070.en-8. Copyright © 2015–2019 Pico Technology Ltd. All rights reserved.

www.picotech.com



Pico Technology



@LifeAtPico



@picotechnologyltd



Pico Technology



@picotech